



KiTa Mahndorfer Heerstraße - Bremen

1 **PROJEKTDARSTELLUNG
ARCHITEKTUR**

2 **NACHHALTIGKEITSKONZEPT**



ÜBER JOHNNY

JOHNNY architecture ist aus dem Bedürfnis nach mehr Dynamik und Innovation in der Architekturbranche geboren. Im Fokus steht die optimale Kombination aus Innovationen und Bewährtem.



Sara Karim

Planungsteam



Jon Steinfeld

Gründer,
Geschäftsführer



Tobias Göttert

Baumanagement,
Geschäftsführer



IOIII



KINDERTAGESSTÄTTE „AM HANLOH“, MUNSTER

JOHNNY



KINDERTAGESSTÄTTE „AUF DEM NOL“, AUGSBURG

JOHNNY

4 REFERENZEN

IOIII
architecture



KULTUR- UND SPORTZENTRUM PLANKSTADT

JOHNNY



UMBAU ALDI FILIALE, ÖTIGHEIM

JOHNNY

1

PROJEKTDARSTELLUNG ARCHITEKTUR

GRUNDSTÜCK



Mahndorfer Heerstraße

Hüllberger Str.

Hüllweger Str.

Anhauser Str.

Risteter Str.

Mahndorfer Heerstraße

Wachendorfer Str.

Holtumer Str.

An d. Lieth

Kordinger Str.

Am Hogenkamp

Mahndorfer Heerstraße



PROJEKT..

4 Gruppen Krippe + 4 Gruppen Kindertagesstätte

Familienzentrum

Träger: Stepkids gGmbH

Qualitätssiegel Nachhaltiges Gebäude Plus (QNG)

Zirkuläres Bauen – Gebäuderessourcenpass

Low-Tech – Kostensicherheit

- BGF: ca. 1.700 m²
- Nutzfläche: ca. 1.500 m²



Übersicht

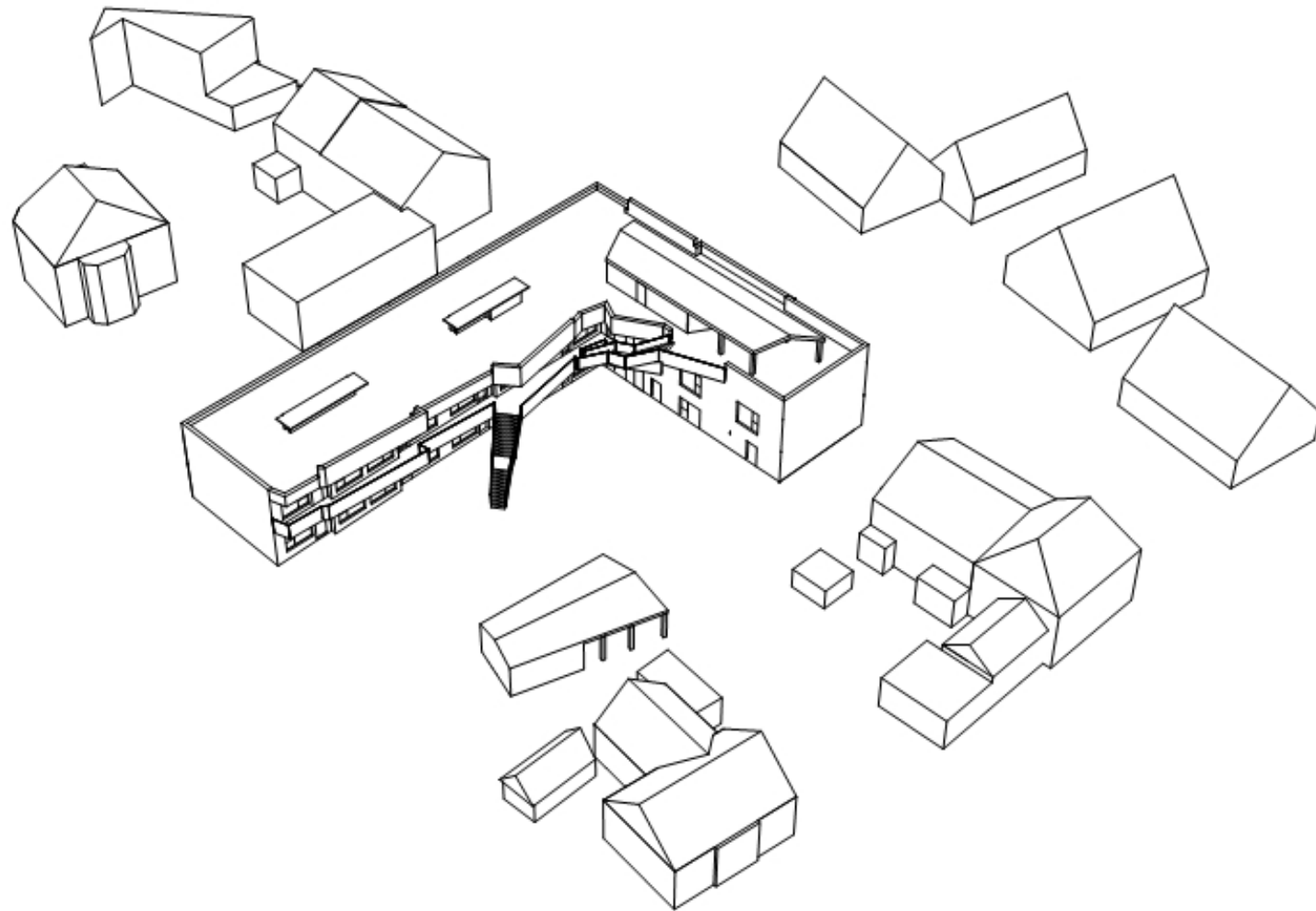

Grundriss EG

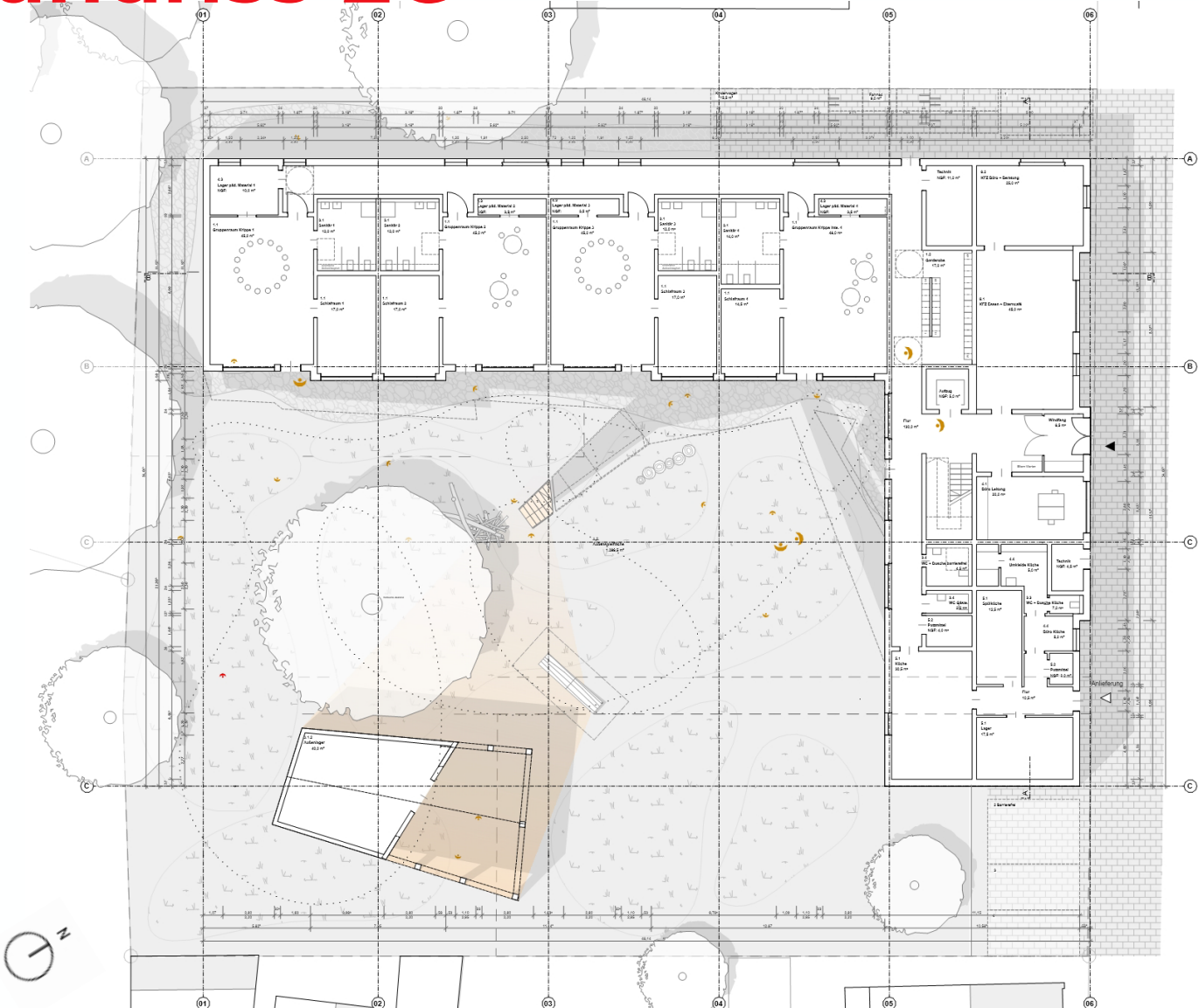

Grundriss 1.OG

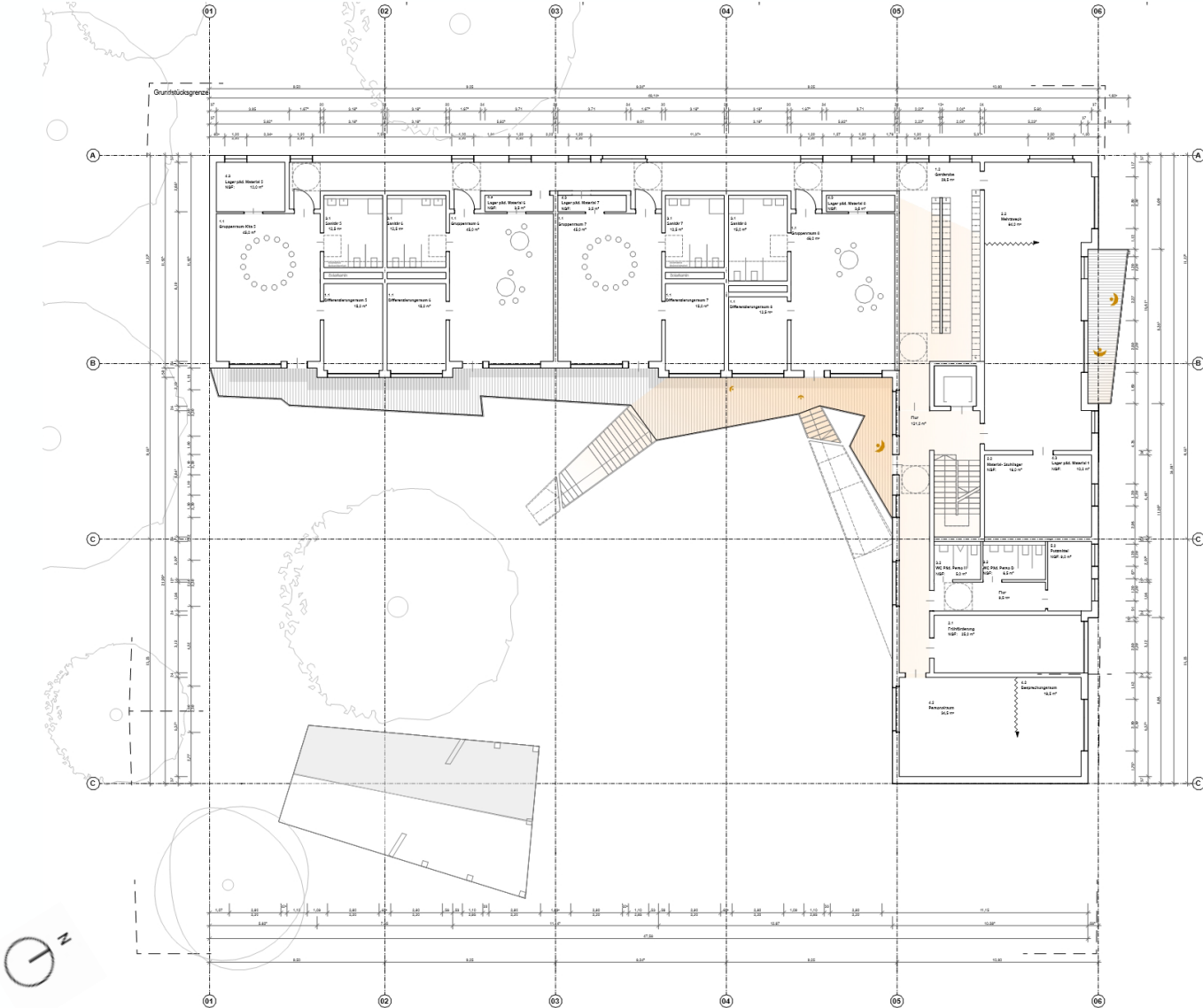

Schnitte

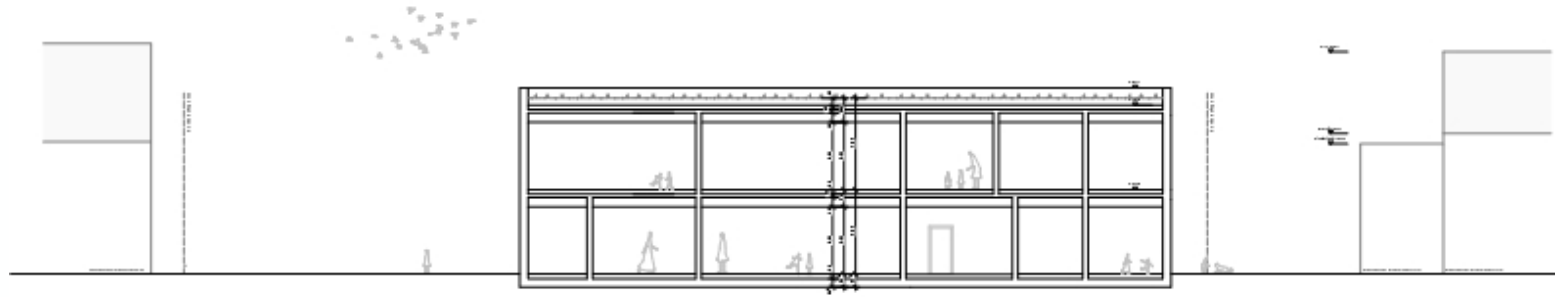

Schnitt A-A

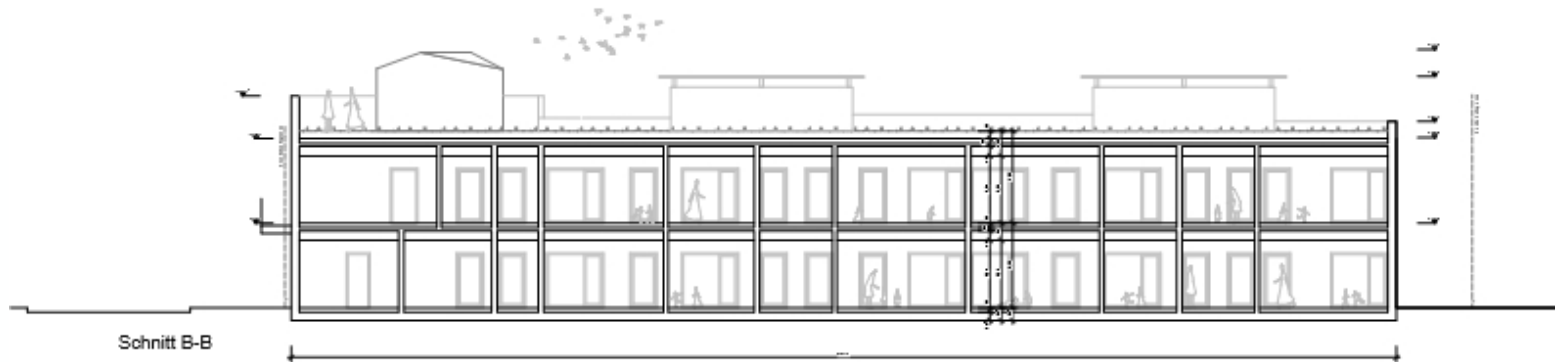

Schnitt B-B

Ansichten

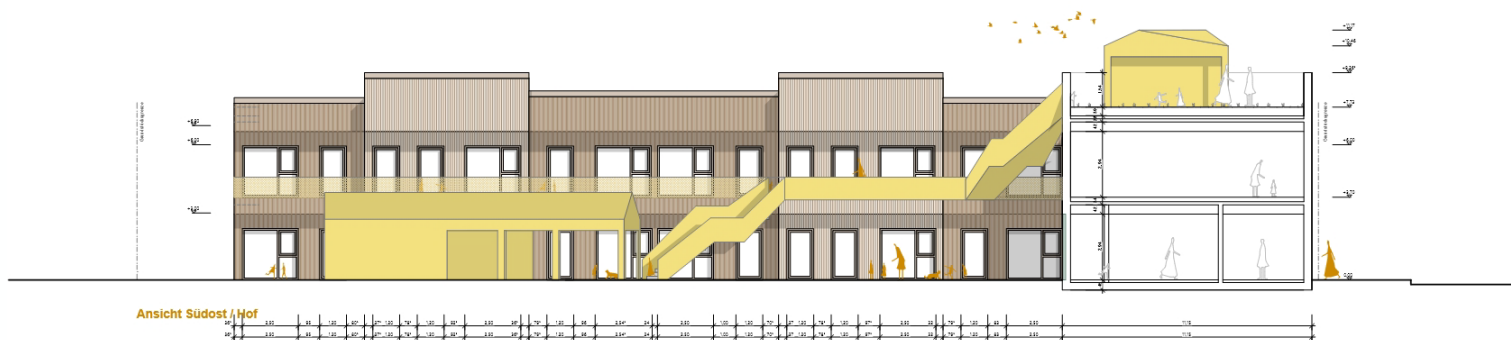

1 PROJEKT
DARSTELLUNG

Einfügung in die Umgebung

Mahndorfer Heerstraße



2

NACHHALTIGKEIT

Wetterdatenvergleich

Jährliche Windrose

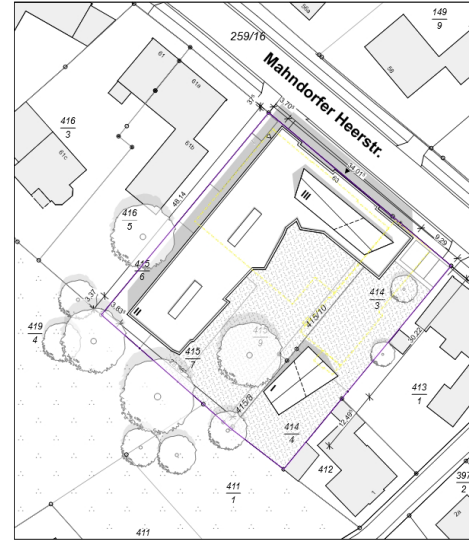
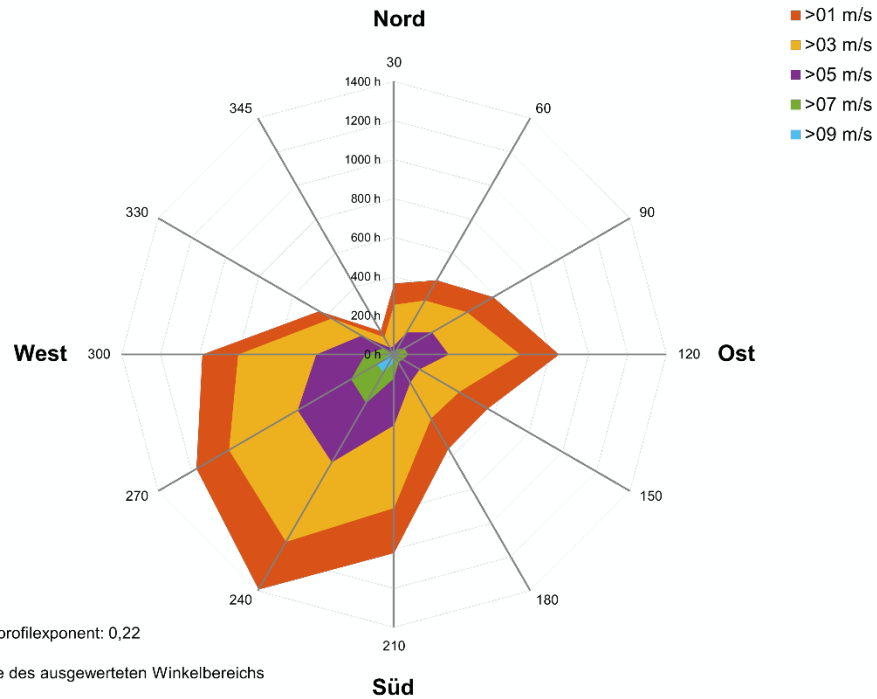

Verfügbare Winddaten: 0 [h]

Höhe: 10 m; Windgeschwindigkeitsprofilindex: 0,22

Gradangaben entsprechen der Mitte des ausgewerteten Winkelbereichs

2 PROJEKT
DARSTELLUNG

Sonneneinstrahlung

Sommerfall 21.06

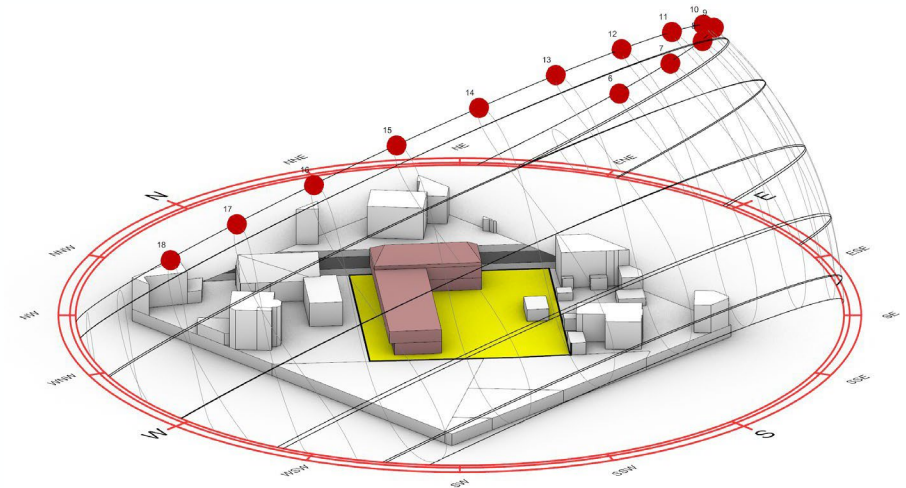
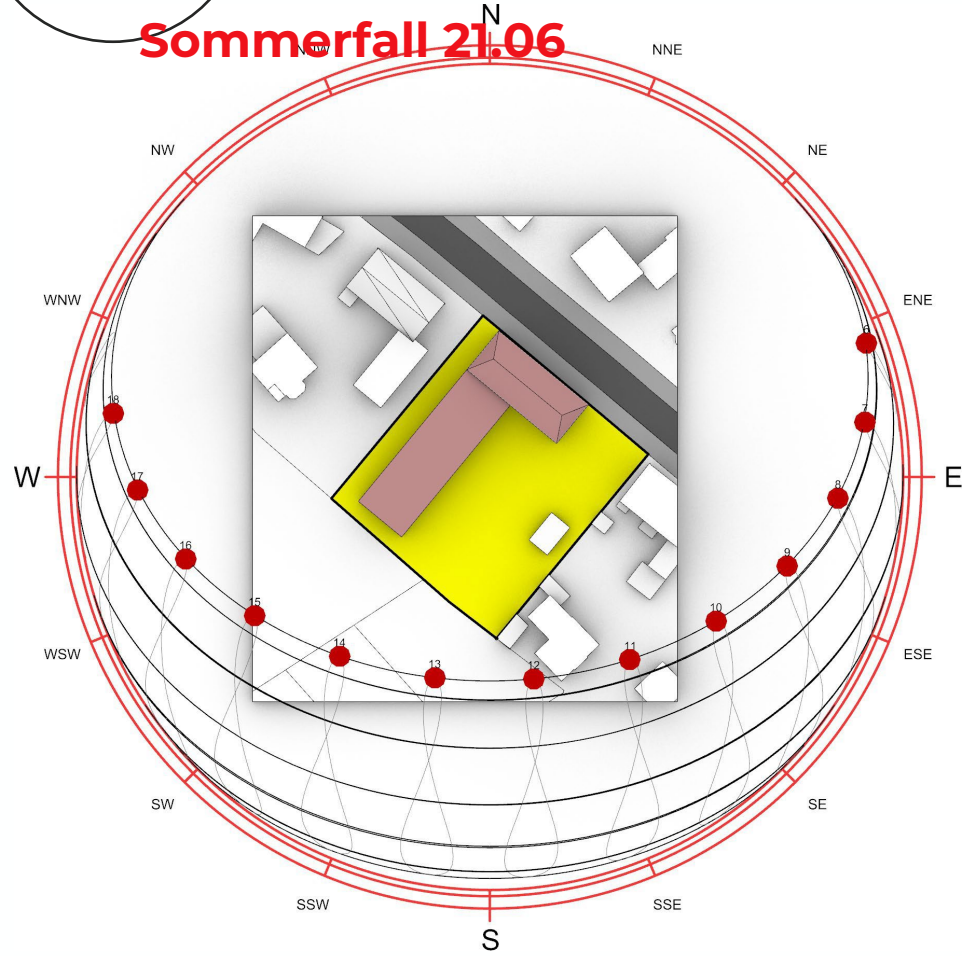

Energiekonzept

Natürliche Lüftung über Solarkamin

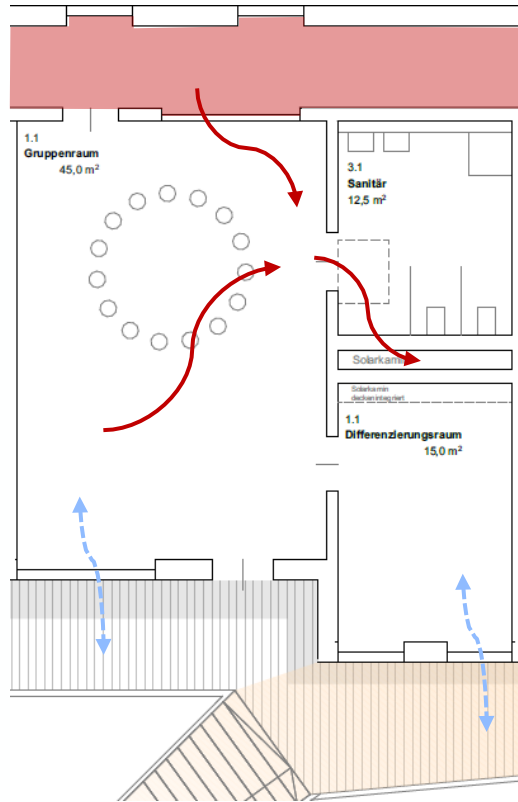

Winterfall

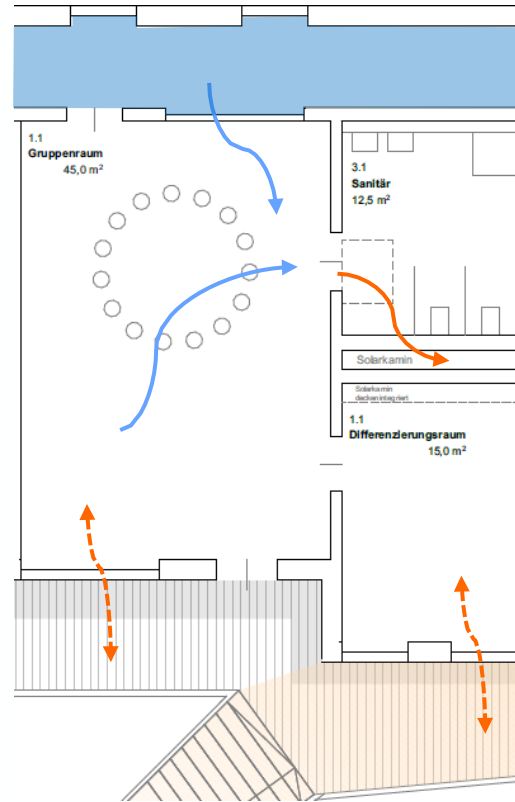

Sommerfall

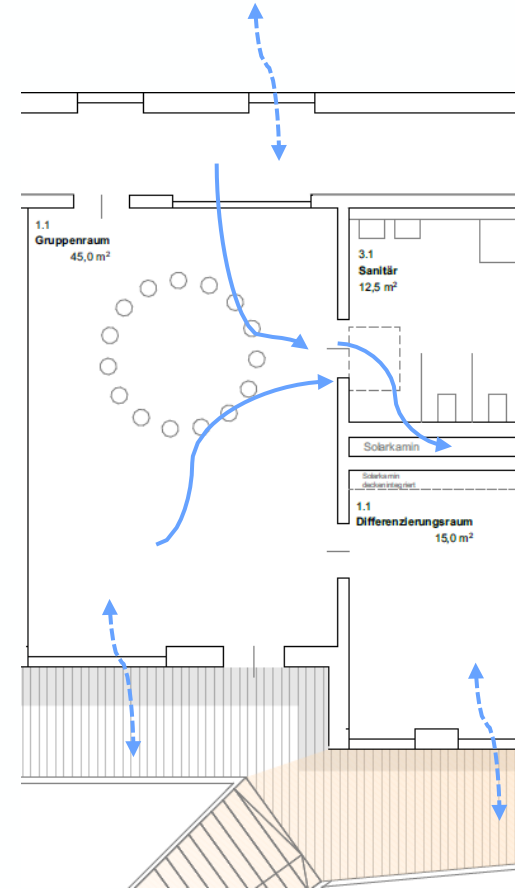

Übergangszeit

KiTa

Mahndorfer Heerstraße - Bremen